

the
SUPER DEFIANT
MODEL SX25
○
OPERATING
ALIGNMENT AND
SERVICING INSTRUCTIONS

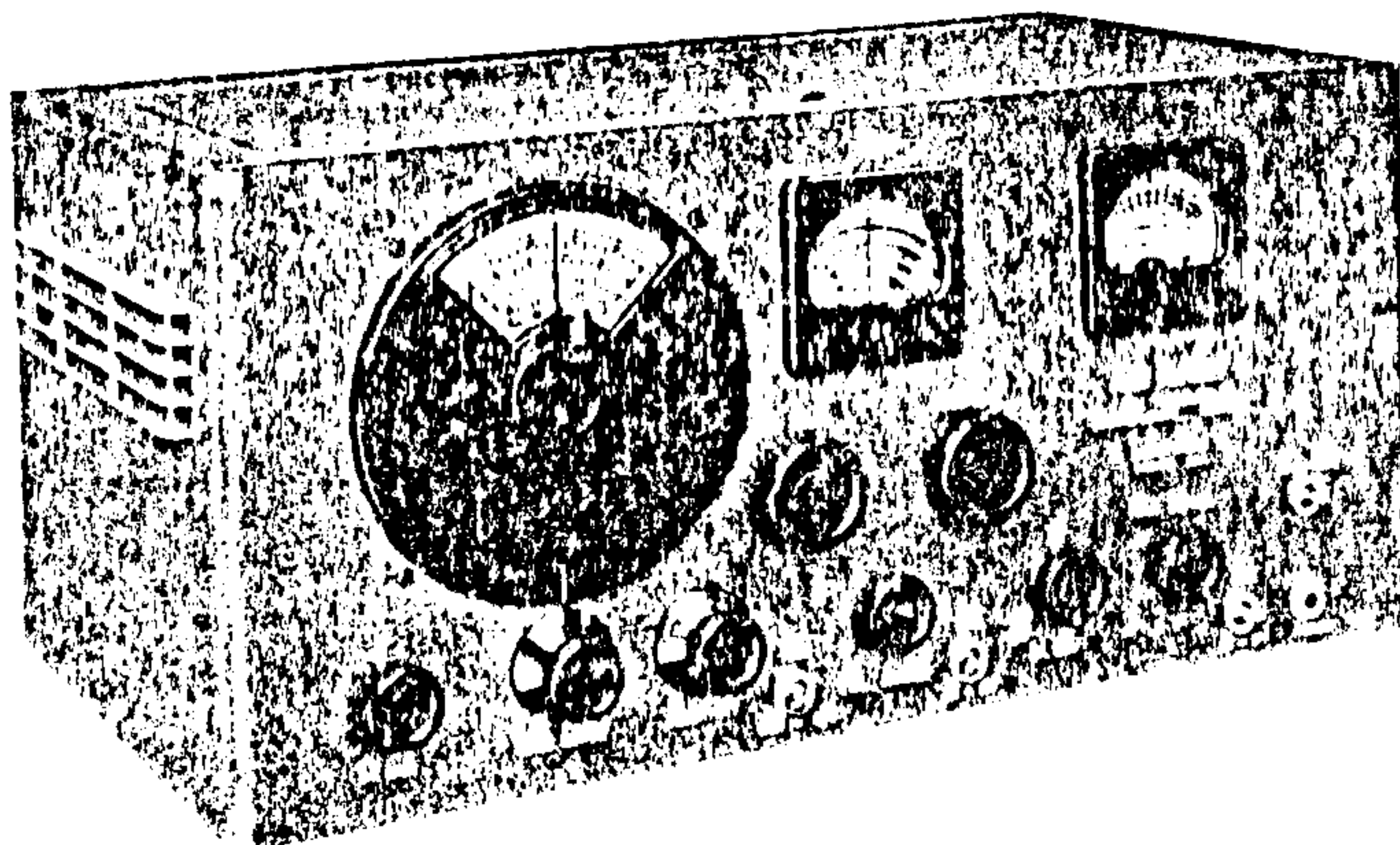

the hallicrafters *co.*
CHICAGO U.S.A.

SUPER DEFIANT MODEL SX25

OPERATING INSTRUCTIONS

The engineers of the Hallicrafters Co. have embodied in the Super Defiant Model SX25 receiver every worthwhile advancement that has been made in the communications field. The user of the SX25 should find in this receiver the complete answer to his reception requirements.

It is recommended that, upon receipt, the owner of the SX25 receiver carefully inspect the carton and then the receiver for any damage which might have occurred in transit. Should any signs of damage be apparent immediately file claim with the carrier accurately stating the extent of the damage.

ANTENNA

The SUPER Defiant has an antenna input circuit which will allow the use of either a doublet or Marconi (inverted "L") antenna. The approximate antenna input impedance of the SX25 is 400 ohms.

A very serviceable antenna will be the inverted "L", or Marconi type. This antenna should be approximately 75 feet long overall, including the lead-in to the set. Satisfactory operation of the SUPER Defiant is obtained throughout its tuning range with this type of antenna and because of that fact as well as its ease of construction it is highly recommended.

With the inverted "L" type of antenna A_2 must remain connected to G for best operation. While a ground connection is usually not necessary it might prove to be helpful in reducing noise. A cold water pipe or 6' foot rod driven in moist soil will be a very satisfactory ground when connected to the G terminal on the receiver. Connections to a radiator or gas piping are not recommended.

Should a doublet antenna be used it is suggested that a transmission line of 400 ohms value of impedance be constructed so that a most efficient transfer of energy is obtained. The commercially available all wave doublet antennas are usually provided with a coupling transformer which matches the transmission line to the receiver. This transformer connects to the A_1 and A_2 terminals on the antenna strip. The half-wave length-doublet antenna cut for a particular frequency can be computed by the following formula:

$$\text{Length in feet} = \frac{463}{\text{Frequency in megacycles}}$$

or for example, a half wave 20 meter or 14 megacycle antenna would be

$$\frac{463}{14} \text{ or } 33.7 \text{ feet long overall}$$

This type of antenna is broken in the center with an insulator and has the transmission line connected to each resulting quarter wave section at that point. This antenna is a very good performer, in a direction broadside to its length, only on the relatively narrow group of frequencies for which it was cut. It does not function well on harmonic frequencies.

When using either type of doublet antennas the transmission line should be connected to A_1 and A_2 binding posts. The wire connecting the A_2 to ground or G can be left connected if the performance of the receiver is improved.

FREQUENCY RANGE

The SUPER Defiant tunes from 540 kilocycles to 42 megacycles in four bands. The frequencies covered per band are as follows:

<u>Band</u>	<u>Coverage</u>
1	540 KC to 1,700 KC
2	1.7 MC to 5.1 MC
3	5.0 MC to 15.7 MC
4	15.2 MC to 42 MC

The main tuning dial, which appears behind the large escutcheon, is accurately calibrated in kilocycles on band #1 and in megacycles on the remaining four bands.

Note: The accuracy of the main dial calibration will hold only if the BAND SPREAD condenser is set at minimum capacity, or the position indicated by 100 on the Band Spread dial which has been approached by turning the Band Spread Knob in a clockwise direction, or to the right, as far as it will go.

When first using the receiver, become familiar with its operation on the standard broadcast band, or Band #1, before tuning the short wave bands. You then will be able to fully appreciate the capabilities of SUPER Defiant.

FREQUENCY METER TUNING

Around the outer edge of the main tuning dial the amateur bands for which "Frequency Meter Tuning" is available are marked with the red numerals; 10 - 20 - 40 and 80. Set the red line beneath these numerals directly opposite the hair-line on the window and switch to the correct band. The band spread scale will indicate correct frequency within the limits of the accuracy of the setting and calibration.

The band spread dial of the SX25 Model is calibrated so that the operator may determine quite closely the frequency of the signal to which he is listening on the 10 to 80 meter amateur bands inclusive. The outer edge of this dial is marked off in 100 divisions for additional ease in logging and locating stations.

<u>Amateur Band</u>	<u>Set Band Switch at</u>
80 Meter	Band 2
40 Meter	Band 3B
20 Meter	Band 3
10 Meter	Band 4

BAND 3B -- Special reference is called to this position of the Band Switch so that no confusion will be experienced. Band 3B is the same as Band 3 and is used in order to have the band spreading of the 40 meter band accomplished through approximately the same number of degrees on the Band Spread Scale as occupied by the other amateur bands for which calibration appears. When the Band Switch is placed in position 3B another section of the band spread condenser is paralleled in the circuit. Band 3 main scale calibration will read somewhat high when the Band Switch is set on 3B.

TUBE LINE-UP

6SK7	1st RF Amplifier	6SQ7	Phase Inverter
6SK7	2 R.F. Amplifier	PP-6F6	2nd audio output stage
6K8	1st Detector-Mixer H.F. Oscillator	6H6	Automatic Noise Limiter
6SK7	1st I.F. Amplifier	6J5GT	Beat Frequency Oscillator
6SK7	2nd I.F. Amplifier	80	Rectifier
6SQ7	2nd Detector, A.V.C. 1st stage of audio		

CONTROLS AND OPERATION

Reading from left to right the functions of the various identified controls will be described.

The "R.F. Gain" control adjusts the sensitivity of the receiver by varying the cathode bias on the R.F. and I.F. amplifiers. Maximum sensitivity will be obtained when this control is rotated as far as it will go to the right. When this has been done a switch will operate which lights the lamp behind the calibrated "S" meter to be described in greater detail later.

The "Band Switch" will allow selection of the frequency ranges through which the receiver tunes. As previously mentioned, Band 3B is to be used when band spreading the amateur 40 meter band.

The "Selectivity - A.V.C. Switch" provides a means of bringing the signal through varying conditions of interference.

When using the receiver for the reception of modulated, or telephone, signals it is advisable to have the switch in anyone of the three "A.V.C. on" positions at which reception is most satisfactory. The three steps of selectivity, namely: BROAD I.F., SHARP I.F., PHONE CRYSTAL, will provide control of selectivity sufficient to meet all normal receiving requirements.

For code or C.W. reception, the Automatic Volume Control circuit should be disconnected by placing the selectivity switch in anyone of the 3 "A.V.C. off" positions. When this has been done the R.F. Gain control should be manually adjusted so that the set will not overload or block on extremely strong signals. The maximum selectivity of the receiver is obtainable with the selectivity switch in the "C.W. XTAL" position. The received signal will be considerably sharper and as a result more care should be exercised in tuning when the C.W. crystal is in the circuit. Careful design of the filter circuit results in improved crystal filter action in the SUPER Defiant which will allow the use of the set under otherwise trying conditions of reception. The phasing control should be adjusted so that the signal on one side of zero beat is reduced in intensity as much as possible. Now carefully tune through the desired signal and notice the distinct increase in signal strength as the resonant frequency of the crystal is reached. Actually the increase in gain in the "C.W. CRYSTAL" position of the selectivity switch is from 2.8 to 4 times more than any other setting of the selectivity control. In addition the PHASING control, when properly adjusted, will prove helpful in coping with conditions of extreme interference. Adjustment of this control for maximum rejection of the unwanted signal, or audio image, will allow true single-signal reception. With the Selectivity Switch in all other positions but C.W. xtal, and "fone xtal" the setting of the phasing control will have no effect on the received signal.

The "PHONE-XTAL" positions are an intermediate step in selectivity between C.W. crystal and I.F. sharp. Phone signals must necessarily be accurately resonated when operating in the Phone Xtal position or side band attenuation will seemingly reduce the strength of the signal.

The "MAIN TUNING" control is for adjusting the main dial of the receiver to the desired frequency.

The "TONE-HIGH LOW" switch directly below the above control in the "High" position gives natural reproduction. In the "Low" position, the highs are cut off, a condition that will be helpful in receiving signals during certain types of interference.

The "CRYSTAL PHASING" control has previously been described in its association with the C.W. xtal selectivity position.

The "BAND SPREAD" knob allows smooth back-lash - free operation of the separate band spread condenser and dial.

The "A.N.L." or automatic noise limiter switch will effectively minimize ignition and similar types of interference which would be objectionable to short wave reception if such a limiting device were not available. Best results are obtained with the A.F. Gain control set near the minimum end.

The "A.F. GAIN" control turns the receiver "off" and "on" as well as controlling the audio output volume of the receiver.

The "PITCH CONTROL" and its associated "BFO- OFF-ON" switch provide a beat note for the reception of C.W. signals. The Pitch Control, when the B.F.O. switch is in the "ON" position allows variation of the frequency of the resultant beat note to a pitch most pleasing to the listener.

The "SEND-RECEIVE" switch momentarily removes plate voltage from the tubes in the receiver so that the set can be made inoperative during stand-by periods.

Into the "PHONE JACK" can be connected any type of high impedance fones, crystal or magnetic, because no direct current flows in the headphone circuit.

"S" METER

When the R.F. gain control is advanced until a switch is heard to operate, a light will appear behind the translucent scale of the meter itself. Only when this light is on will the meter indicate in "S" units. When so adjusted the meter can be used as a resonance indicator. With the R.F. gain control backed off from maximum the meter is still in the circuit but will not indicate carrier level accurately. On the rear apron of the chassis is the "S" meter adjustment screw. To set the "S" meter, disconnect the antenna and have the R.F. Gain Control on full and the selectivity switch in the "I.F. SHARP A.V.C. ON" position. Now, adjust this knurled knob until the meter reads zero. Reconnecting the antenna and tuning in a station will show its relative carrier intensity.

SPEAKER

The 500 and 5000 ohm terminals are for connections to a loud speaker or other load of those impedance values. The matching SX25 speaker should be connected to the 5000 ohm strip. When headphones are plugged into the phone jack the 5000 ohm speaker connection is automatically disconnected.

The "EXT. SWITCH" terminal strip is for external switch provisions should the receiver be controlled by a remote switch or relay. The SEND-REC switch on the panel must be in the Send Position when an external relay is used for stand-by operation.

Unless otherwise specified the SX25 Receiver operates on 100-125 volt 50-60 cycle current. A universal model is available on special order for operation on 110-250 volt, 25-60 cycle current, at a slight increase in price.

The Model SX25 Receiver draws 120 watts at 115 volts 60 cycle alternating current.

The Hallicrafters Co. reserves the right to make changes in design or to add improvements to instruments of their manufacture without incurring any obligation to install the same in any instrument previously purchased.

ALIGNMENT PROCEDURE

455 KC, Intermediate-Frequency Alignment.
Have the controls set as follows:
AF and RF gain controls for maximum volume.
B.F.O. switch in the "ON" position.
Set band switch to #2 band.
Set main dial to 2 megacycles, band spread to 100.
Selectivity switch in "AVC OFF" xtal phone position.

Remove the 6KB tube grid cap. Connect a 1 megohm resistor between grid cap and grid of 6K8 tube. Now connect the hot side of the signal generator to the grid of the 6K8 tube through a .1 MFD condenser. Connect the ground terminal of the signal generator to the chassis of the receiver. Remove modulation from generator and feed a 455 KC signal into the receiver and set the pitch control to give a beat note of approximately 1000 cycles. Adjust all I.F. transformer trimmers for maximum gain with the exception of the secondary trimmer on transformer T1. Identified on top chassis view as T1S. In adjusting this trimmer it will be noted that the output reaches a maximum goes through a dip and then back to maximum again. Wobulate the IF frequency and align to the dip between the two maximum points. A distinct change in the crystal note sounding like an apparent broadening of the crystal action will be noted when the correct adjustment has been reached. At this point in the alignment it is necessary to make an adjustment on the phasing control as follows: Tune the signal generator so that its signal will go through zero beat and then to the other side of zero beat until a signal of approximately 5000 cycles is heard in the speaker or headphones. Now carefully adjust the "PHASING CONTROL" until this signal is reduced in volume to a minimum. Reset the signal generator to its original frequency and recheck the adjustment of T1S. Now repeak carefully the other trimmers on I.F. transformers for maximum gain. Place the selectivity switch in the "CW. XTAL" position leaving all controls on the receiver as previously adjusted. Again wobulate the frequency of the signal generator carefully through the very narrow range of the crystal peak. Adjust small trimmer through hole in the bottom plate marked "TXS" until the sharp crystal peak reaches maximum output. At this point the crystal is extremely sharp and maximum output is possible. If this setting gives too sharp crystal filter action this "TXS" trimmer can be adjusted counter-clockwise for broader crystal response to suit the operator.

B.F.O. ADJUSTMENT

In the center of the "PITCH CONTROL" shaft, after the knob has been removed, you will find a recessed screw for adjustment of the Beat Frequency Oscillator.

Before rotating this screw with a suitable screw-driver loosen the set screw on this shaft. This set screw can be reached through a hole in the bottom plate directly under the B.F.O. Assembly marked "BFA".

Now tune in a signal on the receiver with the BFO off. Exact resonance can be determined with the controls so adjusted that the "S" meter will indicate. After you have assured yourself that you have the signal properly tuned in place the selectivity switch in anyone of the three "AVC OFF" positions. Turn the BFO switch to the "ON" position. You now can adjust the screw in the center of the pitch control shaft until a beat note is heard. Tighten the set screw through the bottom plate, replace the knob and the BFO adjustment is completed.

R. F. ALIGNMENT

Re-connect the grid cap to the 6K8 tube. Connect the hot side of the generator to the A₁ antenna terminal on the rear of the chassis. Be sure a jumper is connected to A₂ and G. Leave signal generator ground connected to the chassis of the receiver.

The location of the following trimmers and padders can be determined by referring to the top and bottom chassis views. All pad adjustments are for the low frequency end of each band while the trimmers are for the high frequency ends.

In order to get at the RF trimmers the guarantee card can be removed by placing a knife under the small snap fasteners holding it in place. So that most satisfactory adjustment of the trimmers and padders can be made, it is advisable to "Rock" the condenser gang across the signal being delivered by the generator until that particular circuit has been accurately peaked.

Bands	Trim at	Pad at
1	1500 KC Adjust C _A C _B C _C	600 KC Adjust Pad Band 1
2	4 MC Adjust C _D C _E C _F C _G	1.8 MC Adjust Pad Band 2 (Top Chassis)
3	14 MC Adjust C _H C _I C _J C _K	6 MC Adjust Pad Band 3
4	30 MC Adjust C _L C _M C _N C _O	18 MC No pad on this Band

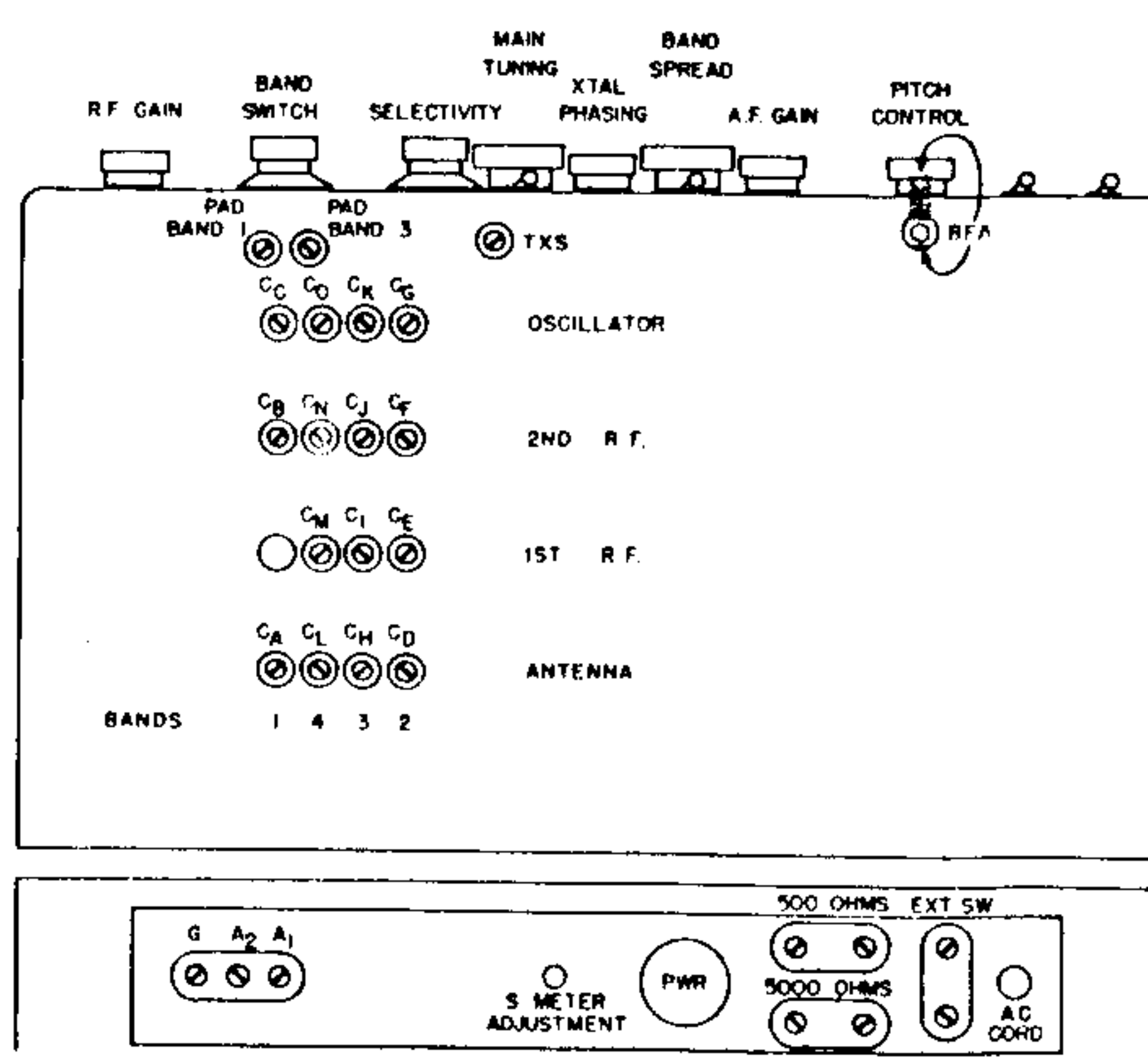
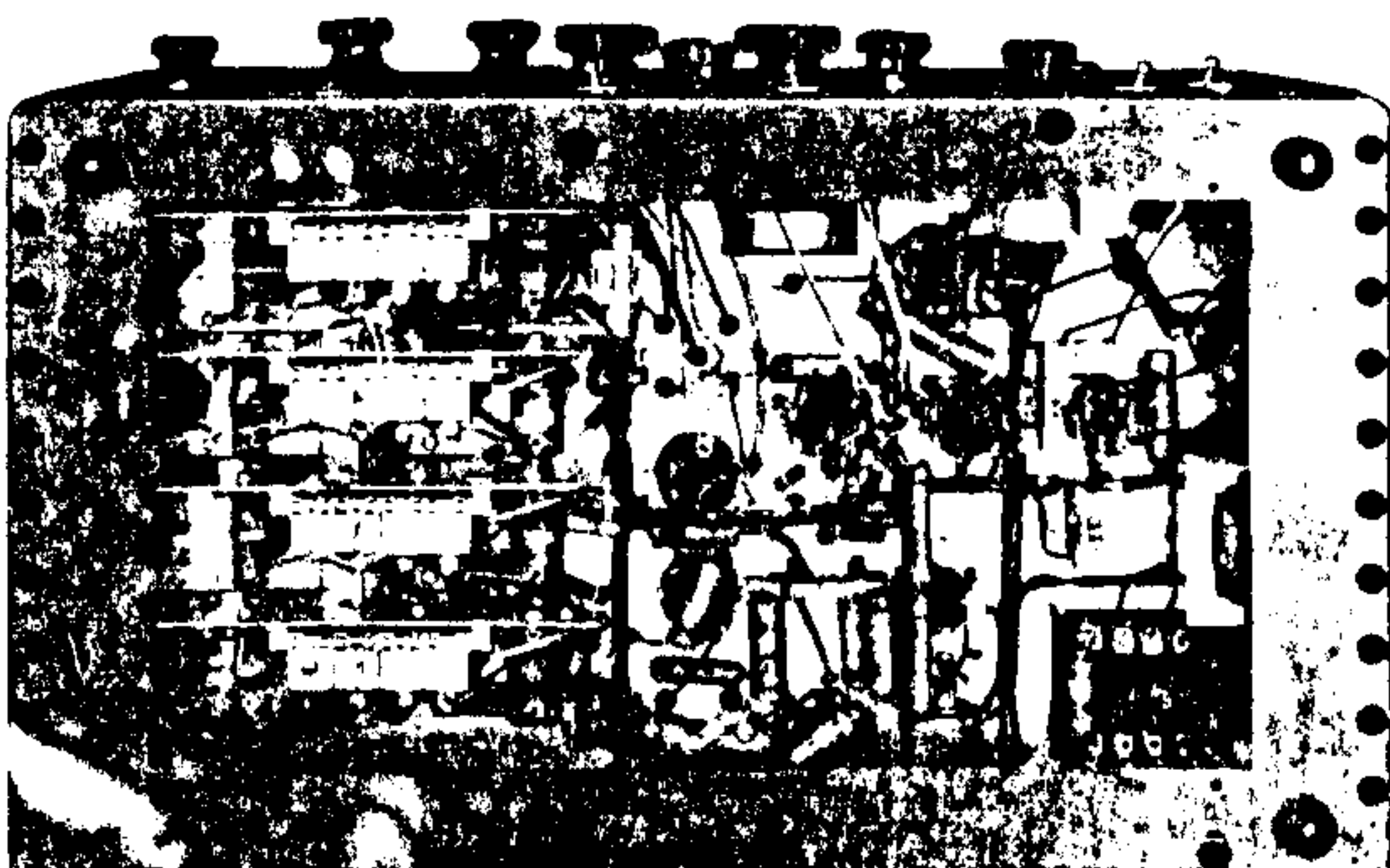
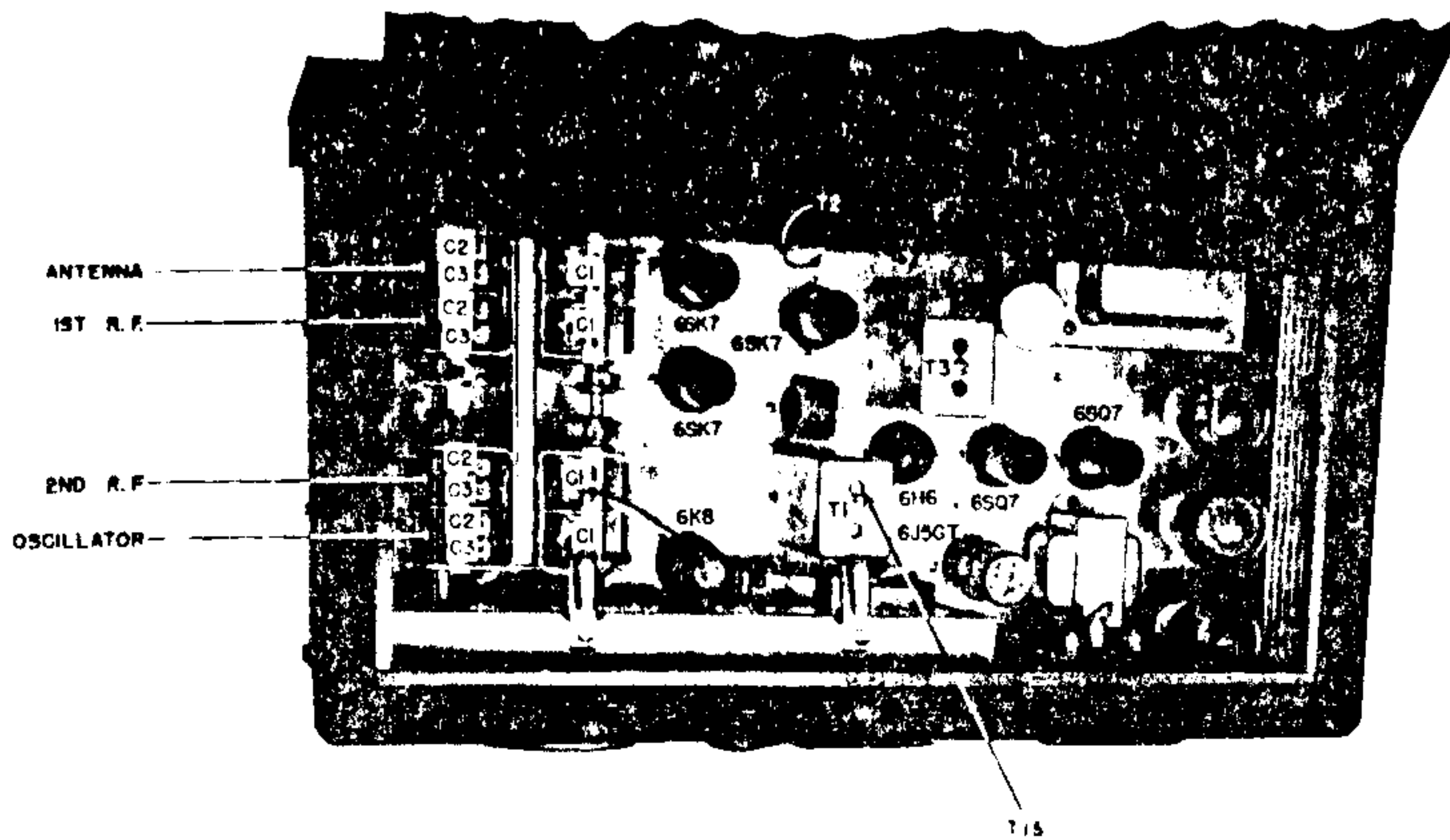

GUARANTEE

This receiver is guaranteed to be free from any defect in workmanship and material that may develop within a period of ninety (90) days from date of purchase, under the terms of the standard guarantee, as designated by the Radio Manufacturers Association. Any part or parts that prove defective within this period will be replaced without charge when subjected to examination at our factory, providing such defect, in our opinion, is due to faulty material or workmanship, and not caused by tampering, abuse or normal wear. All such adjustments to be made F.O.B. the factory.

Should this receiver require any adjustments, your dealer or distributor has complete technical service in-

formation, or the factory will be glad to assist you in any problem direct.

Should it be necessary to return any part or parts to the factory, a "Return Material Permit" must be obtained in advance by first writing the Adjustment Department, who will issue due authorization under the terms of the guarantee.

The Hallicrafters Co. reserves the right to make changes in design or add improvements to instruments manufactured by them, without incurring any obligation to install the same in any instrument previously purchased.

All Hallicrafters receivers are built under patents of Radio Corporation of America and Hazeltine Corporation.

PARTS LIST

SUPER DEFIANT MODEL SX25

RESISTORS

NO.	OHMS	WATTAGE	NO.	OHMS	WATTAGE
R1	100,000	1/2	23	3,000	1/2
2	400	"	24	50,000	"
3	100,000	"	25	100,000	"
4	10,000	R. F. Gain	26	250,000	"
5	500	S Meter	27	250,000	"
6	30	1/2	28	1,000,000	"
7	3,000	"	29	1,000,000	"
8	100,000	"	30	500,000	A.F. Gain
9	300	"	31	250,000	1/2
10	500	"	32	250,000	"
11	3,000	"	33	250,000	"
12	100,000	"	34	250,000	"
13	250	"	35	200,000	"
14	50,000	"	36	350	2
15	30,000	2	37	20,000	2
16	25,000	2	38	15,000	2
17	4,000	2	39	15,000	2
18	100,000	1/2	40	150	1/2
19	500,000	"	41	50,000	"
20	800	"	42	20,000	2
21	3,000	"	43	8	1/2
22	300	"			

CONDENSERS

NO.	CAPACITY	VOLTAGE	TYPE	NO.	CAPACITY	VOLTAGE	TYPE
C1	Main Tuning Gang			30	13 mmfd		Twisted Pair
2	2 PL. Bd. Spr. Sec.			31	.02 mfd	600	Paper
3	5 " " " "			32	.01 mfd	400	Paper
4	.01 mfd	400	Paper	33	.05 mfd	200	Paper
5	.05 mfd	200		34	.002 mfd	1,600	Tubular Oil
6	.05 mfd	200	Paper	35	250 mmfd		Mica
7	.02 mfd	600	Paper	36	.05 mfd	400	Paper
8	.05 mfd	200	Paper	37	30 mfd	25	Electrolytic
9	35 mmfd		Ceramicon	38	.05 mfd	400	Paper
10	.05 mfd	200	Paper	39	20 mfd	25	Electrolytic
11	.02 mfd	600	Paper	40	.002 mfd	1,600	Tubular Oil
12	.05 mfd	200	Paper	41	.1 mfd	400	Paper
13	5-6.5 mmfd		Ceramicon	42	10 mfd	350	Electrolytic
14	35 mmfd		Ceramicon	43	30 mfd	350	Electrolytic
15	.05	200		44	.01 mfd	600	Paper
16	.05 mfd	400	Paper	45	100 mmfd		Mica
17	.02 mfd	600	Paper	46	500 mmfd		Mica
18	4.5 mmfd		Compensating	47	.02 mfd	600	Paper
19	10 mfd	350	Electrolytic	48	105 mmfd		Ceramicon
20	.05 mfd	200	Paper	49	.002 mfd		Mica
21	3-25 mmfd		Phasing	50	105 mmfd		Ceramicon
22	1.5 to 20 mmfd "TXS"		Trimmer	51	2100 mmfd		Dual Pad
23	2 to 30 mmfd		Trimmer	52	1300 mmfd		Single Pad
24	.05 mfd	200	Paper	53	430 mmfd		Dual Pad
25	.02 mfd	600	Paper	54	.1 mfd	200	Paper
26	.05 mfd	200	Paper	55	700 mmfd		Mica
27	.02 mfd	600	Paper	56	.25 mfd	200	Paper
28	50 mmfd		Mica	57	Twisted Pair		
29	100 mmfd		Mica	58	Twisted Pair		

SWITCHES

SW1 - AC ON-OFF on A.F. Gain Control	SW5 - High-Low Tone SPST
SW2 - Stand-by SPST	SW6 - "S" Meter on R.F. Gain Control
SW3 - B.F.O. ON-OFF SPST	SW7 - Band switch rotary selector
SW4 - A.N.L. ON-OFF SPST	SW8 - Selectivity switch rotary selector

2nd DET.-A.V.C.
1st A.F.

2nd I.F.

1st I.F.

1st DET.-MIX
H.F. OSC.

2nd R.F.

1st R.F.

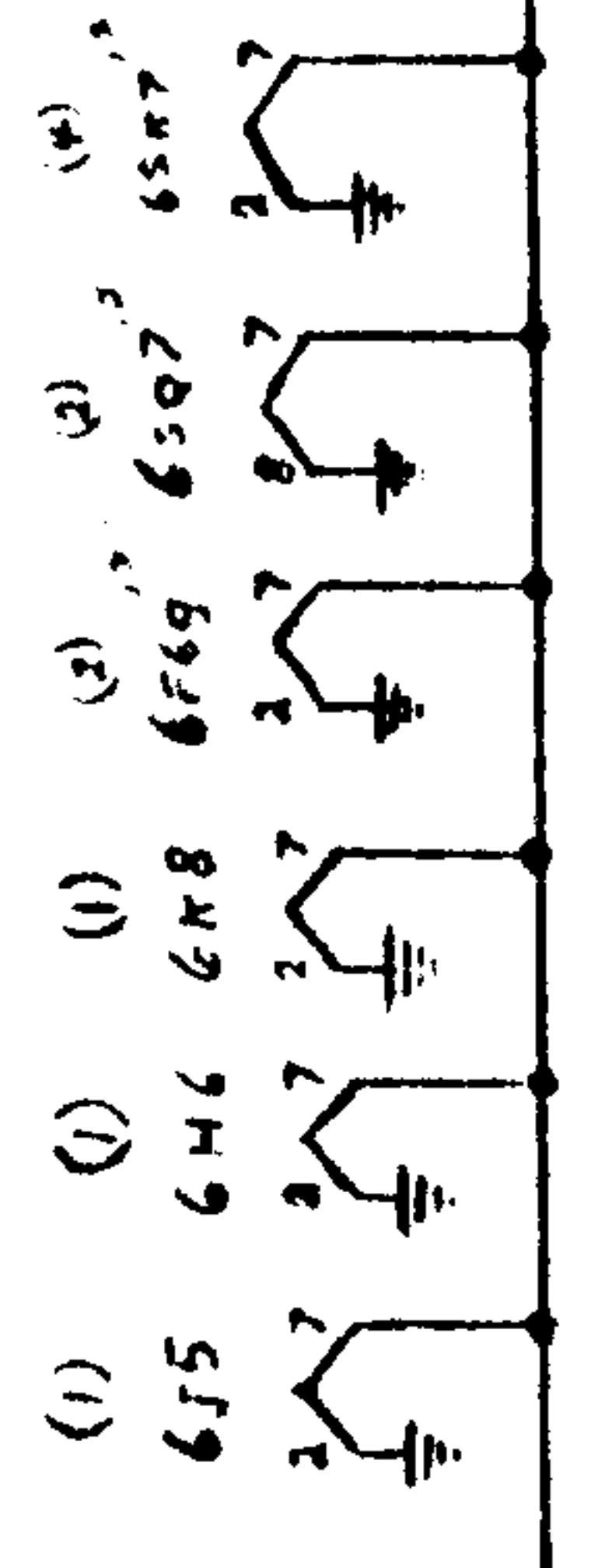
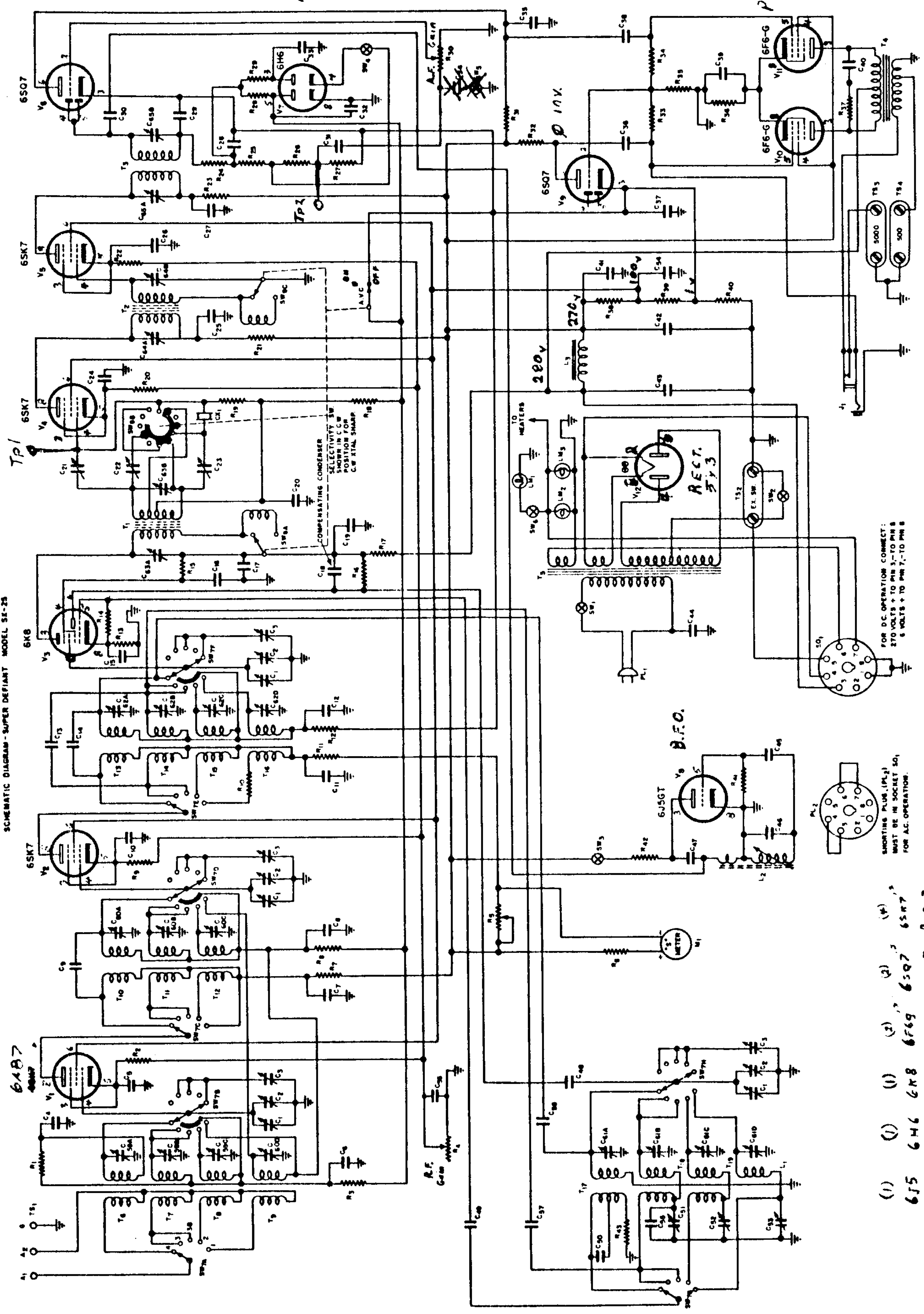

FOR DC OPERATION CONNECT:
270 VOLTS + TO PIN 3, - TO PIN 8
& VOLTS + TO PIN 7, - TO PIN 8

TO 6.3 V
AC - DC
HEATERS

TP1

V4

V5

V6

V7

V8

V9

V10

V11

V12

V13

V14

V15

V16

V17

V18

V19

V20

V21

V22

V23

V24

V25

V26

V27

V28

V29

V1

V2

V3

V4

V5

V6

V7

V8

V9

V10

V11

V12

V13

V14

V15

V16

V17

V18

V19

V20

V21

V22

V23

V24

V25

V26

V1

V2

V3

V4

V5

V6

V7

V8

V9

V10

V11

V12

V13

V14

V15

V16

V17

V18

V19

V20

V21

V22

V23

V24

V25

V26

V1

V2

V3

V4

V5

V6

V7

V8

V9

V10

V11

V12

V13

V14

V15

V16

V17

V18

V19

V20

V21

V22

V23

V24

V25

V26

V1

V2

V3

V4

V5

V6

V7

V8

V9

V10

V11

V12

V13

V14

V15

V16

V17

V18

V19

V20

V21

V22

V23

V24

V25

V26

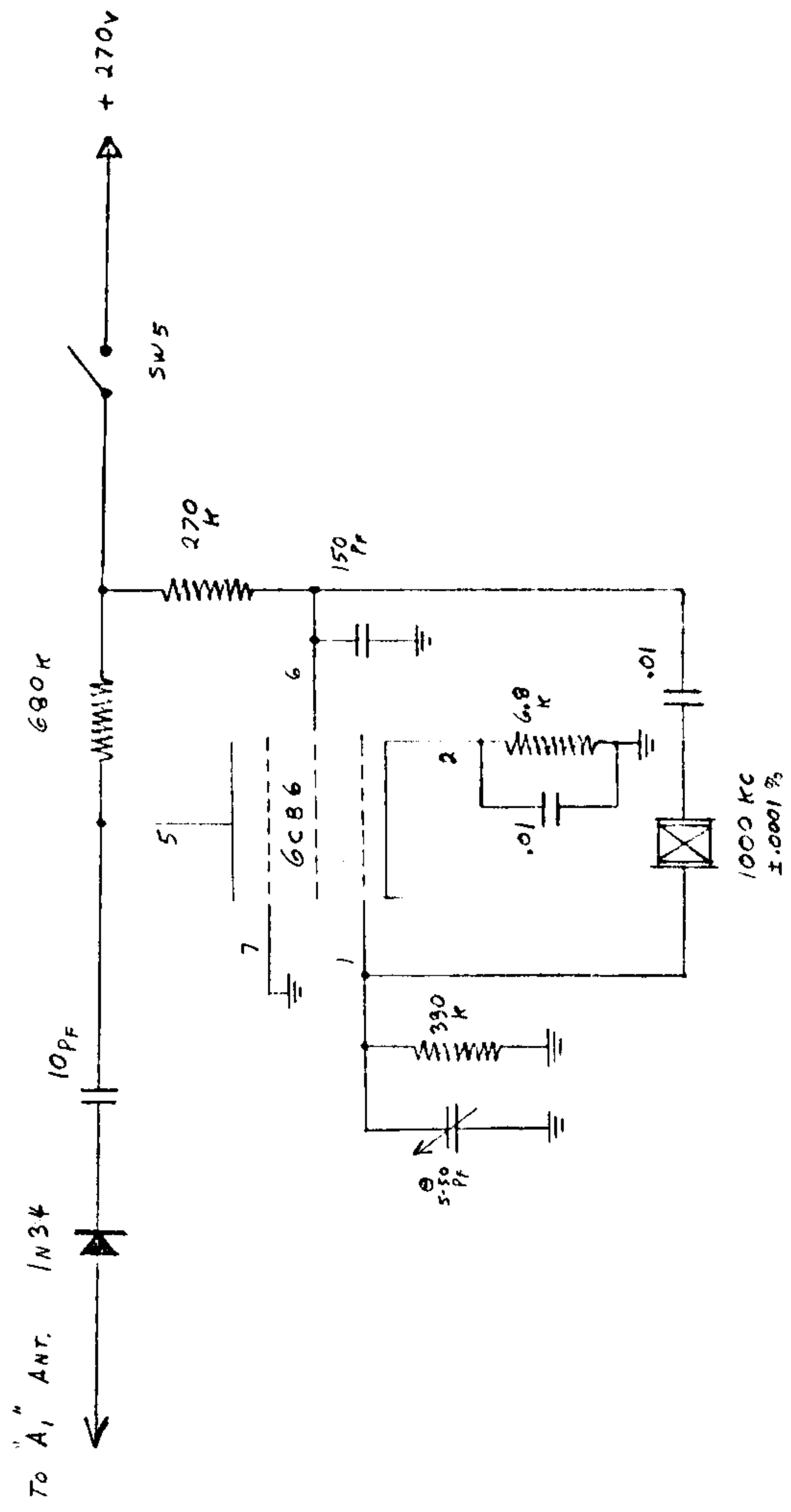

XTAL CALIBRATOR

DIAL CODE STRINGING DIAGRAM SK 25

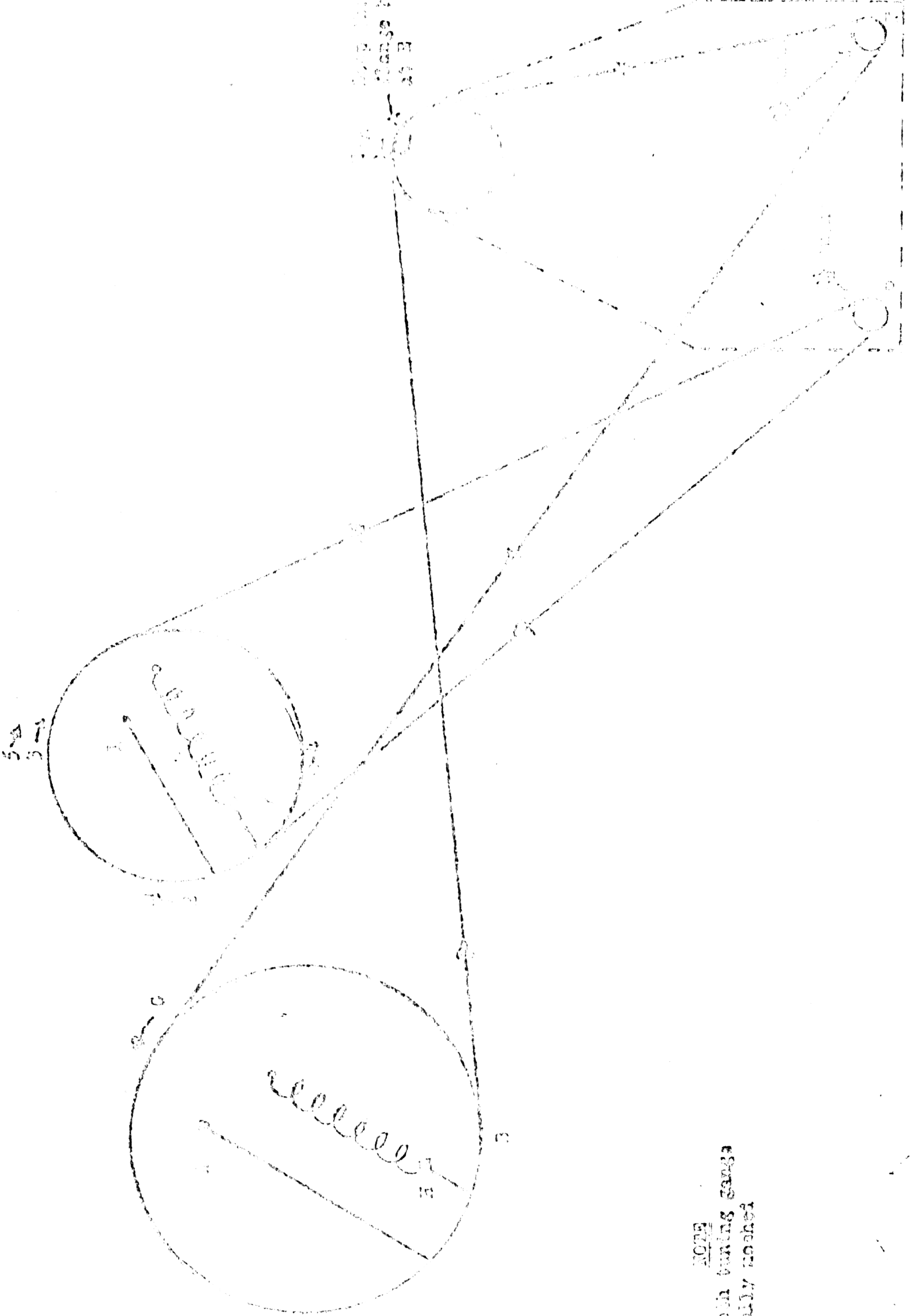

NOTE:
Both turning gears
fully meshed

SECRET
 AUTHORITY: 20 CFR 171.16
 CONTROLLED

Headlines are free socket pin to ground, except where otherwise specified

No Antenna and ground
RF and **AF** gain maximum
 Sharp If, AVC on.
 Band #1 Gangs open
 117 volts AC input

Percent tolerance allows
 variation of plus minus
 10% from indicated values.

SOCKET CONTACTS	1	2	3	4	5	6	7	8
1st RF 6KS7	0	0	4	slight neg.	4	100	6.3 AC	250
2nd RF 6SK7	0	0	4	0	4	100	6.3	250
Converter 6KB	0	0	250	105	varies with tuning	180	6.3	4.8
1st IF 6SK7	0	0	5	slight pos.	5	100	6.3	250
2nd IF 6SK7	0	0	5½	0	5½	100	6.3	250
2nd Det. 6SQ7	0	0	1	slight	pos.	150	6.3	0
Phase Inv. 6SQ7	0	slight pos.	1	0	0	150	6.3	0
Amp. 6V6	0	0	280	270	slight pos.	6.3	18	
Amp. 6V6	0	0	280	270	slight pos.	6.3	18	
AMP. 6H6	0	0	slight positive			0	6.3	0
Rect. 80	280 DC	300 AC	300 AC	280 DC	5 volt AC reading between pin #1 and #4			
PFO 6J5	0	0	135	0	32	250	6.3	0